



Best aid
SAFEWAY

ISO-9001

VQV

MOST SUITABLE FOR VERTICAL MACHINE CENTER

最適合立式綜合切削加工機，銑床使用

FMS · Power

彈性化 / 高倍力型

- MODEL • 10140160 VQV-160V-L • 10142200 VQV-200V-BL • 10146200 VQV-200V-XL
 • 10142160 VQV-160V-XL • 10144200 VQV-200V-L

VQV

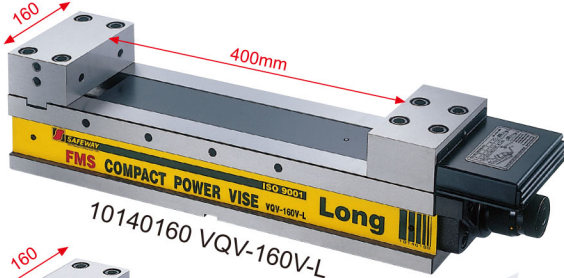

**High Power
Soft Drive-Handle
工件夾緊力超大
把手旋轉力超軟**

Jaw Width/口金寬度: 160
Jaw Opening/最大開口: 400
Total Length/總長度: 696

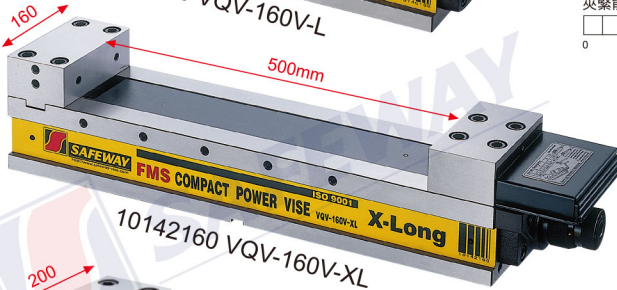
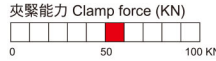

Jaw Width/口金寬度: 160
Jaw Opening/最大開口: 500
Total Length/總長度: 796

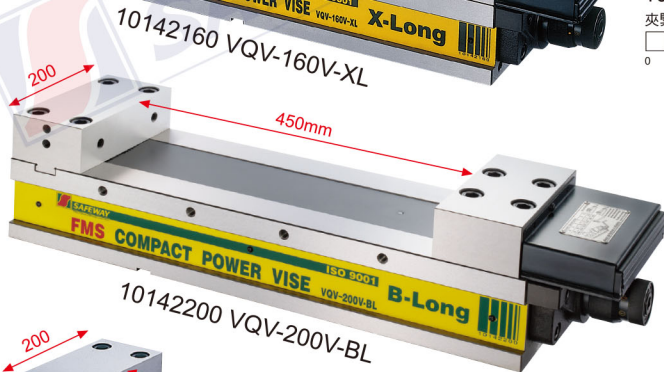
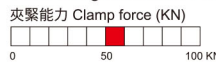

Jaw Width/口金寬度: 200
Jaw Opening/最大開口: 450
Total Length/總長度: 761

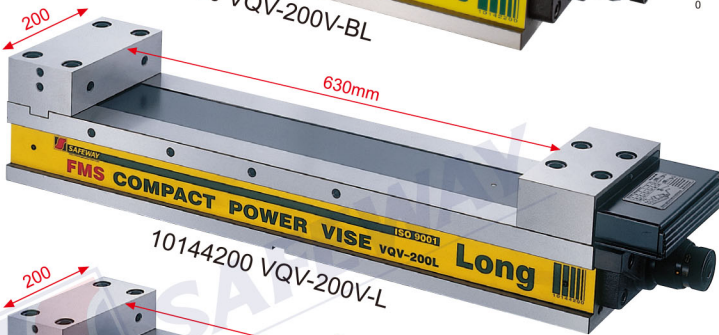
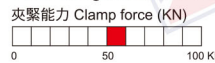

Jaw Width/口金寬度: 200
Jaw Opening/最大開口: 630
Total Length/總長度: 941

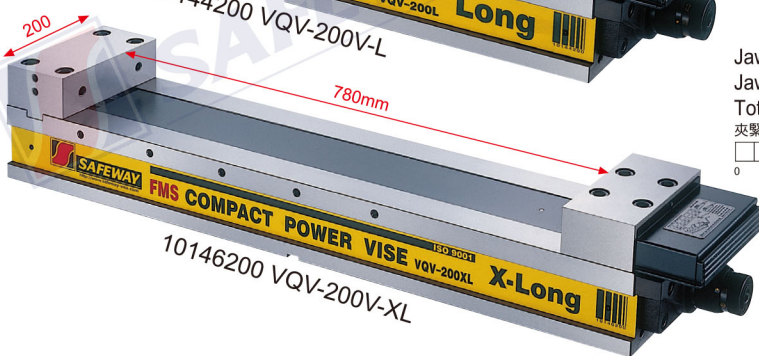
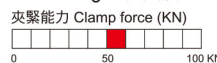

Jaw Width/口金寬度: 200
Jaw Opening/最大開口: 780
Total Length/總長度: 1086

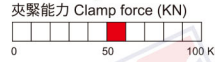

FEATURES :

- Max. opening capacity and compact in total length. Particularly suitable for machining centers.
- Clamping system: Mechanical power.
- Drive spindle with clamping force presetting and stopper mechanism device.
- Rigid material-ductile iron FCD600 JIS (Equal to GGG-60) with 60kgs/mm² or 80,000psi tensile strength.
- Vise bed flame hardened to HRC45° and up takes up wear and maintain accuracy for long.
- Stationary jaw and movable jaw are hardened HRC55° with grinding.
- Stationary jaw and movable jaw are easy to shift on the clamping slide.
- Chip cover adopt on each vise for preventing chips falling into lead-screw and inside of vise.

特性 :

- 角固式肯倍得式精密倍力機械增壓虎鉗，適用立、臥式綜合切削加工機做精密切削加工。並設計有夾持力顯示功能，可知夾持力之大小。
- 夾緊系統：倍力式 / 機械增壓。
- 高倍力式機構可隨時設定夾持力大小，且重覆多次使用皆保持相同夾持力，及一致精度，並設計有夾持力過負荷保護裝置。
- 強而有力材質~虎鉗本台使用高抗張拉力球狀石墨化鑄鐵 (FCD600~60kgs/mm²) (80,000psi) 抗張力強，不易變形。
- 虎鉗本台滑動面均經硬化熱處理 HRC45°以上，可保持長久耐用性及精度。
- 固定口金，活動口金鋼製熱處理 HRC55°以上，並經精密研磨。(容易拆裝)
- 虎鉗防屑設計，以防止加工鐵屑傾入傳動螺桿及虎鉗內部，不易清除。
- 大開口，適合大型工件做精密加工。

CLAMPING FORCE TABLE / 夾緊力表 KN (kgf)

	4	3	2	1	0
VQV-160	54(5292)	43(4214)	21(2058)	12(1176)	5(490)
VQV-200	66(6468)	48(4704)	22(2156)	12(1176)	5(490)

Unit: mm

高倍力機械增壓夾緊力大且穩定，適用於超重切削精密加工。

Order NO. 訂購編號	Model 型號	Jaw Width 口金寬度	Jaw Height 口金高度	Jaw Opening J (J1) 開口範圍 J (J1)	Vise Height 虎鉗高度	Total Height 全高	Total Length 全長	Limit. Pressure 最大夾緊力	Remark 備註
10140160	VQV-160V-L	160	55	400	105	160	696	54KN(5292kgf)	
10142160	VQV-160V-XL	160	55	500	105	160	796	54KN(5292kgf)	
10142200	VQV-200V-BL	200	60	450	110	170	761	66KN(6468kgf)	
10144200	VQV-200V-L	200	60	630	110	170	941	66KN(6468kgf)	
10146200	VQV-200V-XL	200	60	780	110	170	1086	66KN(6468kgf)	
10141160	VQV-160V-L-SJ	160	55	470	105	160	696	54KN(5292kgf)	
10143160	VQV-160V-XL-SJ	160	55	570	105	160	796	54KN(5292kgf)	
10143200	VQV-200V-BL-SJ	200	60	526	110	170	761	66KN(6468kgf)	
10145200	VQV-200V-L-SJ	200	60	706	110	170	941	66KN(6468kgf)	
10147200	VQV-200V-XL-SJ	200	60	856	110	170	1086	66KN(6468kgf)	



FMS COMPACT POWER VISE (LONG OPENING)

FMS彈性化 / 肯倍得式精密高倍力機械增壓虎鉗(大開口)

- MODEL • 10141160 VQV-160V-L-SJ • 10143200 VQV-200V-BL-SJ • 10147200 VQV-200V-XL-SJ
 • 10143160 VQV-160V-XL-SJ • 10145200 VQV-200V-L-SJ

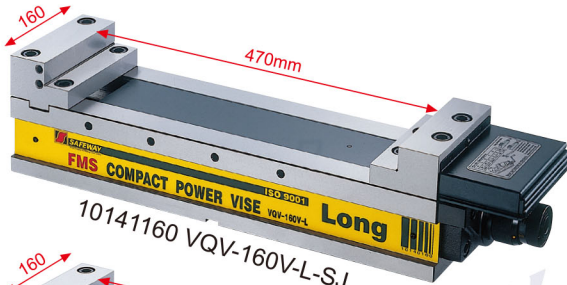

Jaw Width/口金寬度: 160
 Jaw Opening/最大開口: 470
 Total Length/總長度: 696

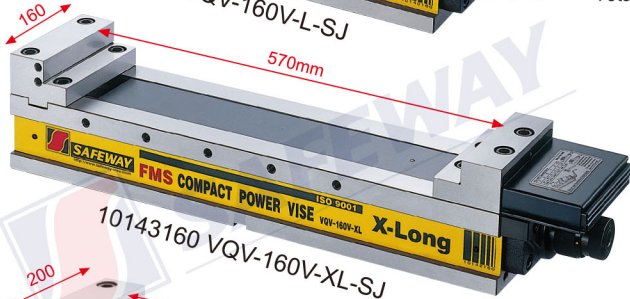

Jaw Width/口金寬度: 160
 Jaw Opening/最大開口: 570
 Total Length/總長度: 796

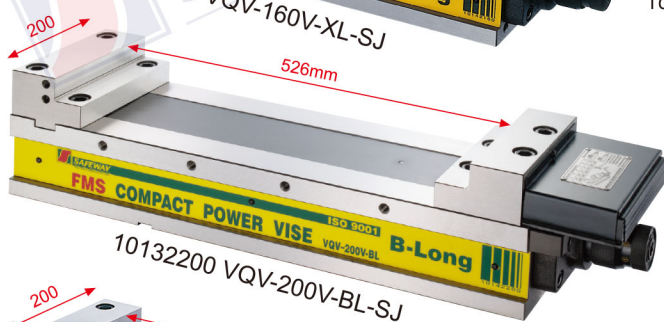

Jaw Width/口金寬度: 200
 Jaw Opening/最大開口: 526
 Total Length/總長度: 761

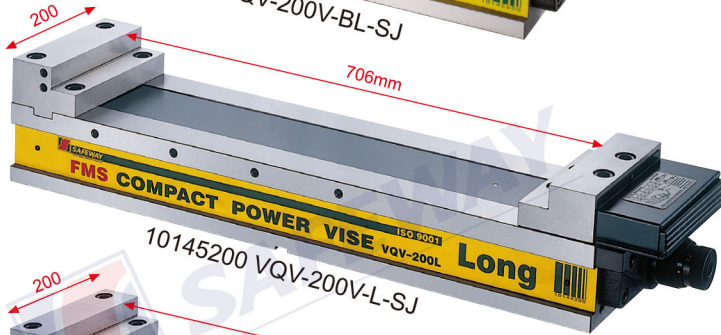

Jaw Width/口金寬度: 200
 Jaw Opening/最大開口: 706
 Total Length/總長度: 941

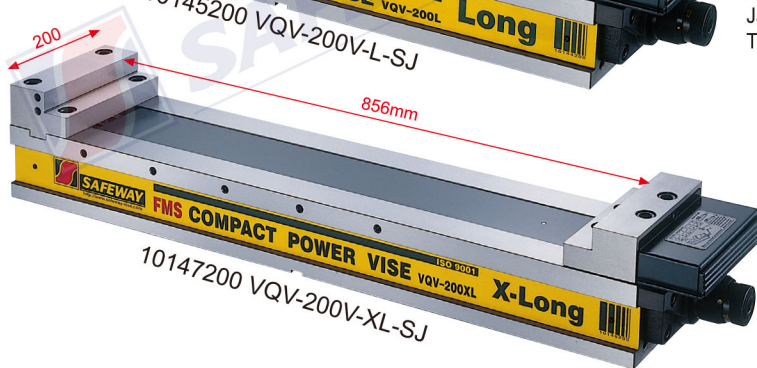

Jaw Width/口金寬度: 200
 Jaw Opening/最大開口: 856
 Total Length/總長度: 1086

DIMENSIONS / 尺寸圖

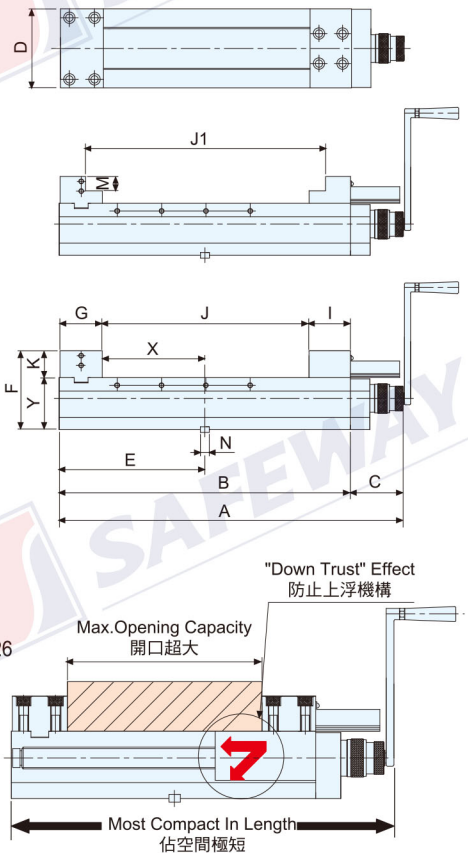

- Clamp power intensification via "Lead - screw" intensifier.
- Lower deformable design for very high clamping accuracy.

Standard Accessories

1. Handle x 1 pc
2. Guide key x 2 pcs (18mm)
M6 x 10L x 2 pcs
3. Vise locked block x 6 pcs
4. Chip cover x 1 set

標準附件

1. 把手一組
2. 導正鍵 x 2只 (18mm)
螺絲 x 2只 (M6 x 10L)
3. 虎鉗固定塊 x 6只
4. 虎鉗防屑蓋

PATENTED / 專利在案

Unit: mm, kg

Order NO. 訂購編號	Model 型號	A	B	C	D	E	F	G	I	J/J1	K	M	N	X	Y	N.W. 淨重	G.W. 毛重	Shipment Size 裝箱尺寸	Remark 備註
10140160	VQV-160V-L	696	590	106	161	295	160	86	86	400	55		18	208	105	68	72	940x280x220	
10142160	VQV-160V-XL	796	690	106	161	345	160	86	86	500	55		18	258	105	75	78	940x280x220	
10142200	VQV-200V-BL	761	655	106	201	327.5	170	100	97	450	60		18	227	110	100	111	809x370x290	
10144200	VQV-200V-L	941	835	106	201	418	170	100	97	630	60		18	316	110	118	138	1205x410x280	
10146200	VQV-200V-XL	1086	980	106	201	490	170	100	97	780	60		18	388	110	131	153	1300x410x280	
10141160	VQV-160V-L-SJ	696	590	106	161	295	160	86	86	470	55	30	18	208	105	66	70	940x280x220	
10143160	VQV-160V-XL-SJ	796	690	106	161	345	160	86	86	570	55	30	18	258	105	73	76	940x280x220	
10143200	VQV-200V-BL-SJ	761	655	106	201	327.5	170	100	97	526	60	30	18	227	110	98	109	809x370x290	
10145200	VQV-200V-L-SJ	941	835	106	201	418	170	100	97	706	60	30	18	316	110	114	134	1205x410x280	
10147200	VQV-200V-XL-SJ	1086	980	106	201	490	170	100	97	856	60	30	18	388	110	126	149	1300x410x280	